

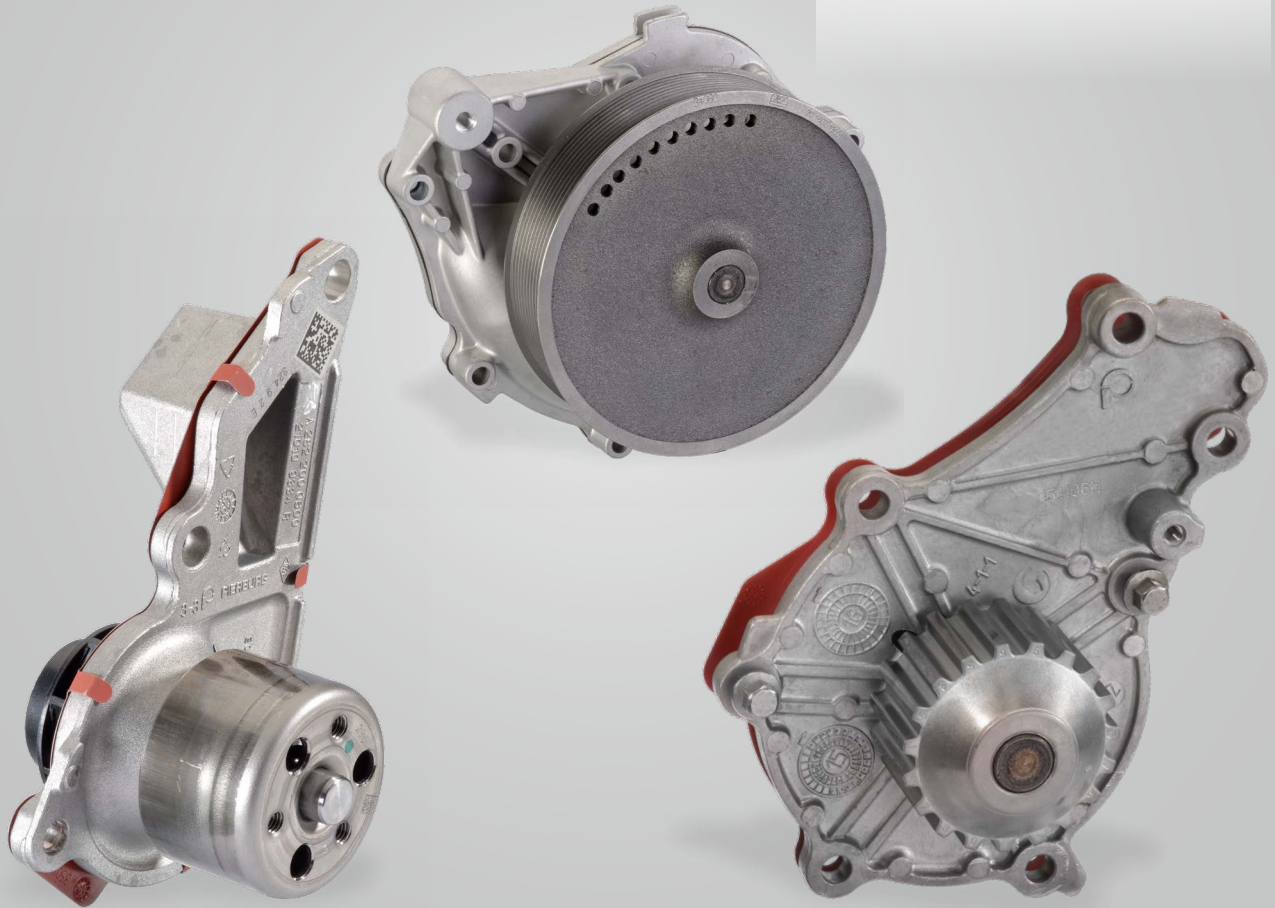

PIERBURG



KNOWLEDGEPOOL

**WATER PUMPS –
WITH MECHANICAL DRIVE**

PASSION FOR **TECHNOLOGY.**



RHEINMETALL



MOTORSERVICE GROUP

QUALITY AND SERVICE FROM A SINGLE SOURCE

The Motorservice Group is the sales organisation for the global aftermarket activities of Rheinmetall. It is a leading supplier of engine components for the independent aftermarket. With the premium brands Kolbenschmidt, Pierburg, TRW Engine Components and the brands BF and turbo by Intec, Motorservice offers its trade and repair shop customers a wide and comprehensive range of top-quality products.

RHEINMETALL

TECHNOLOGY FOR FUTURE MOBILITY

As a global supplier to the automotive industry, Rheinmetall's expertise in air supply systems, emission control and pumps and in the development, manufacture and spare parts supply of pistons, engine blocks and engine bearings puts it right at the top of the markets. Product development is carried out in close cooperation with well-known automotive manufacturers.



KOLBENSCHMIDT



PIERBURG



Edited by:
Motorservice, Technical Market Support

Layout and production:
Motorservice, Marketing

This document must not be reprinted, duplicated or translated in full or in part without our prior written consent or without reference to the source of the material.

All content including pictures and diagrams is subject to alteration. No liability accepted.

Published by:
© MS Motorservice International GmbH

Liability

All information in this brochure has been carefully researched and compiled. Nevertheless, it is possible that errors have occurred, information has been translated incorrectly, information is missing or the details provided have changed in the intervening time. As a result, we are unable to provide any guarantee nor to accept any legal liability for the accuracy, completeness, currency or quality of the information provided. We hereby waive all liability for any damages, whether direct or indirect in nature and whether tangible or intangible, resulting from the use or misuse of information or from incomplete or incorrect information in this brochure, unless proven to be the result of deliberate intent or negligence on our part. Likewise, we shall not be liable for damage arising because the engine reconditioner or mechanic does not have the necessary technical expertise, the required knowledge of, or experience in repairs. The extent to which the technical methods and repair information described here will apply to future engine generations cannot be predicted and must be verified in individual cases by the engineer servicing an engine or the workshop operator.

CONTENTS		PAGE
1.	BASIC INFORMATION	5
1.1	Task of the water pump	5
1.2	Installation locations and types of drive for water pumps	6
1.3	Design and function of the water pump	7
1.4	Bearing designs	7
1.5	Sliding ring seal package	8
1.6	Ventilation holes and leakage holes	10
1.7	Leak reservoir	10
1.8	Sealing of the pump housing	11
1.9	Cooling liquid	12
2.	INSTALLATION AND SERVICE	16
2.1	Cleaning the cooling system	16
2.2	Dismantling the old water pump	16
2.3	Installing the new water pump	17
2.4	Gaskets and liquid sealants	17
2.5	Belt drive and belt tension	18
2.6	V-belt and V-belt pulleys	18
2.7	Filling the cooling system	19
2.8	Initial start-up	19
2.9	Running-in the water pump	20
2.10	Mixing the cooling liquid	20
2.11	The most important rules for handling water pumps and cooling liquid	21
3.	DAMAGE AND CAUSES OF FAILURE	22
3.1	Bearing damage	22
3.2	Leaks	23
3.3	Cavitation	24
3.4	Corrosion	26



MECHANICAL WATER PUMPS FROM PIERBURG AND BF

The mechanical water pumps produced by Pierburg and BF stand out thanks to their excellent quality, function and durability. Around 6 million water pumps for motor vehicles and utility vehicles are produced every year at the production sites in Germany, France, Italy, Brazil and the USA.

Various types of closed and open pump impellers are used in the mechanical water pumps. The latest calculation methods and flow simulation tools are used to optimise the pump impellers in terms of the hydraulic requirements, the pump efficiency and the geometry, taking into account the manufacturing process.

Tailored solutions featuring various materials such as aluminium, stainless steel and plastic are assessed during construction and calculation, and the solution that has the best technical properties and is the most cost-effective is developed to be ready for the market. In the test laboratories, we recreate the most extreme conditions for day-to-day operation and the water pump is monitored by a computer to ensure full functionality.

Synonyms for the terms used:

- Coolant agent = undiluted anti-freeze / anti-corrosion agent
- Cooling liquid = water / coolant agent mixture
- Water pump = cooling liquid pump



1. BASIC INFORMATION

1.1 TASK OF THE WATER PUMP

Combustion in the engine creates heat. The cooling liquid absorbs the heat from the engine block and cylinder head and releases it into the ambient air through the radiator. The water pump circulates the cooling liquid in the closed cooling system.

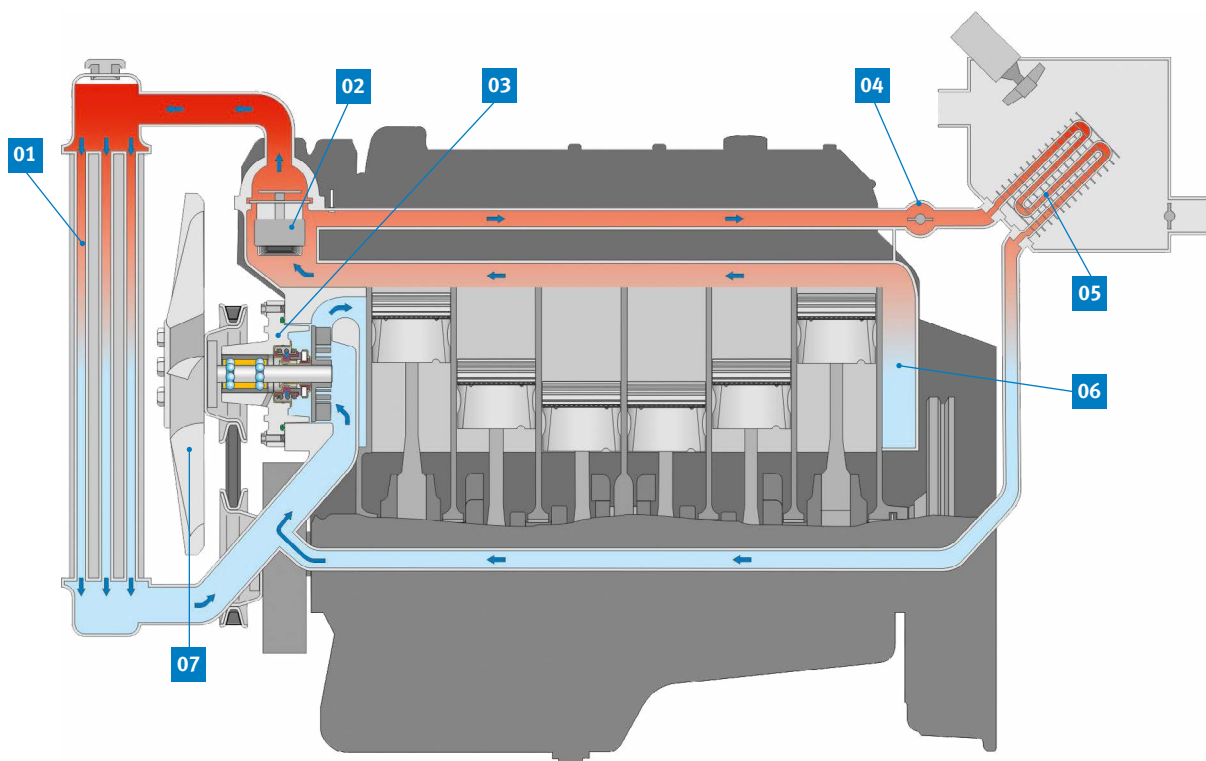

Cooling system

- 01 Radiator
- 02 Thermostat
- 03 Water pump
- 04 Control valve
- 05 Heat exchanger
- 06 Cooling jacket
- 07 Radiator fan

1.2 INSTALLATION LOCATIONS AND TYPES OF DRIVE FOR WATER PUMPS

Depending on their design, mechanical water pumps are located either externally on the engine in their own pump housing or are flanged directly on the engine block.

Water pumps that are fitted externally on the engine are driven by a belt that normally also drives additional accessories such as the generator, servo pump or air conditioning compressor. In this case, the force transmission is performed using V-belts or poly-rib belts (poly V-belt, poly-rib).

In passenger cars, flanged water pumps are normally driven via the timing belt of the valve control system. The type of installation makes this water pump type easier to design and fewer components are required compared with water pumps that are fitted externally on the engine. However, the replacement of timing belt driven water pumps is a more labour-intensive process than the replacement of V-belt-driven water pumps.

During replacement, the entire timing belt drive of the engine must be opened and disassembled. This is a complex intervention in the control of the camshaft drive. For a great deal of engines, it is essential to have engine-specific professional knowledge.

Special tools and adjustment values such as the valve timing, the belt tension and the start of delivery of the fuel injection pump (where applicable) are required for a large number of engines. Even minor deviations or errors made during this work can cause serious engine damage.



Mounted pump (without V-belt pulley)



Flanged pump with timing belt drive

1.3 DESIGN AND FUNCTION OF THE WATER PUMP

Mechanical water pumps are made up of the following main groups:

- 01** Drive pulley
- 02** Bearing with pump shaft
- 03** Pump housing
- 04** Sliding ring seal cartridge
- 05** Impeller

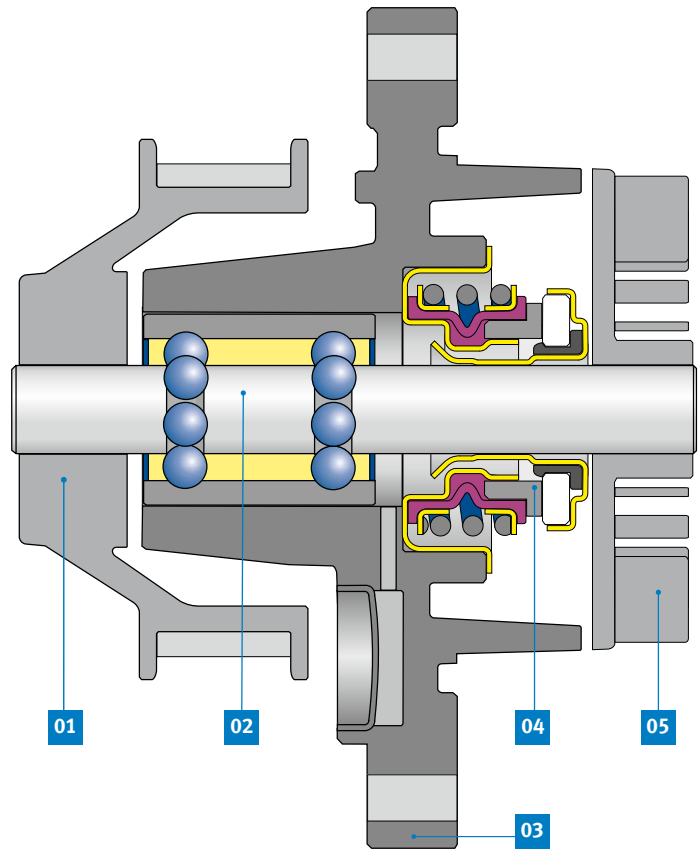

Timing belt driven water pump flanged on the engine

1.4 BEARING DESIGNS

Mechanical water pumps feature two rows of ball bearings (Fig. 1) or, in the case of increased bearing load, combined ball / roller bearings (Fig. 2). The bearings are provided with a lifetime grease filling. In order to prevent the ingress of water and dirt, the bearings are sealed on both sides with a radial shaft seal. In water pumps, the bearing shaft is also a component of the bearing. This means that the balls or rollers roll directly off the pump shaft.

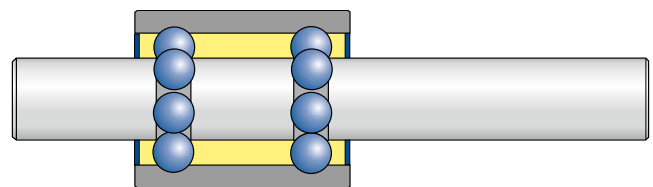

Fig. 1: Ball bearing

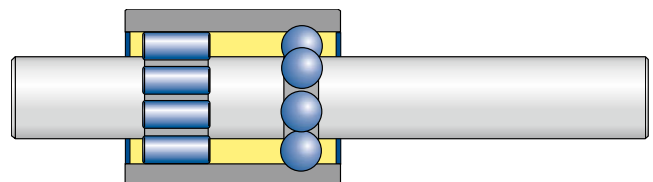

Fig. 2: Ball / roller bearing

1.5 SLIDING RING SEAL PACKAGE

The sliding ring sealing cartridge is the actual sealing of the water pump. It essentially consists of two sliding rings and a spiral spring. The tribological pairing primarily consists of sliding rings that are made up of different materials. Depending on the durability requirements and operating conditions, hard carbon (graphite), aluminium oxide, tungsten carbide or silicon carbide may be used. The spiral spring presses the sliding rings onto one another in order to maintain the sealing effect in an unpressurised cooling system.



Sliding ring seal package, ready to install and disassembled

As with almost all designs in which two surfaces run against each other, lubricant is required in order to reduce the friction. In the sliding ring seal package, the cooling liquid in the cooling system is responsible for the lubrication and the cooling of both slide rings. As a result of the pressure in the cooling system and the rotation of the pump shaft, the cooling liquid enters between the sliding rings and enables low-wear liquid friction. To ensure the function and the attainment of the intended service life, it is always necessary for there to be a small flow of cooling liquid through the sliding rings.

ATTENTION

This functional principle may lead to small leaks of cooling liquid on the outer face of the pump. This small leak is design-related and is not a cause for complaint.

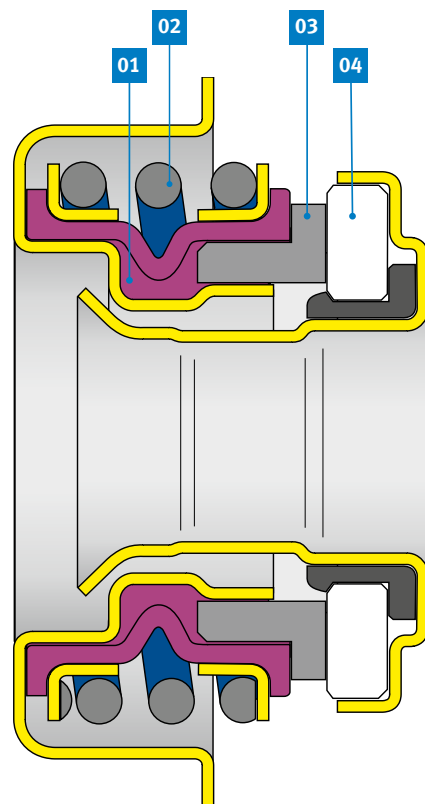

Structure of the sliding ring seal package

- 01 Bellows
- 02 Spiral spring
- 03 Sliding ring (fixed)
- 04 Sliding ring (rotating)

1.6 VENTILATION HOLES AND LEAKAGE HOLES

The amount of cooling liquid that enters between the contact surfaces of the sliding rings and reaches the outer face is very small and is normally evaporated in the water pump itself. For this purpose, the pump housing features ventilation holes or leakage holes through which the cooling liquid can escape into the surrounding area. Glycol-based coolant agent contains colours and additives, meaning that coloured residue is formed on the outer face in the area of the leakage holes of the water pump.

Without the leakage holes, cooling liquid would accumulate between the sealing ring package and the pump bearing and it would penetrate into the pump bearing.

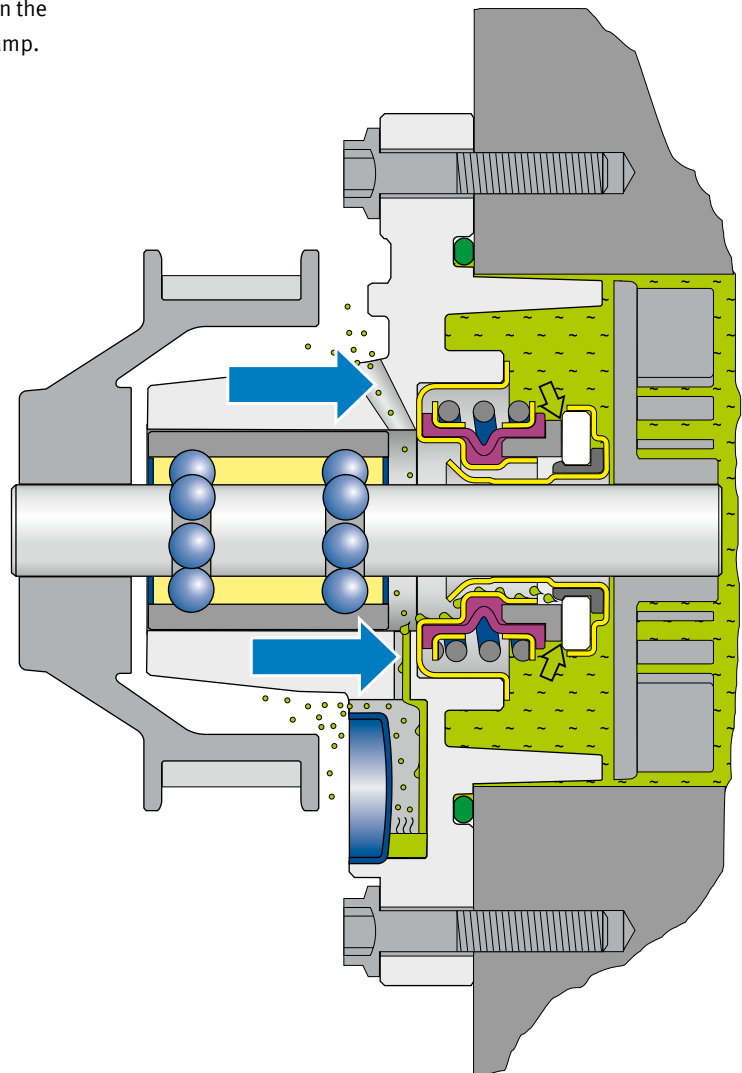

Ventilation hole and leakage hole

1.7 LEAK RESERVOIR

The visible cooling liquid residue on the leakage hole that was referred to above is frequently diagnosed as a water pump leakage by persons lacking the necessary professional knowledge. However, this minor leak is no reason to replace the water pump.

In order to prevent this misunderstanding, many engine manufacturers have switched to providing the water pumps with a reservoir at the leakage hole.

The small quantities of cooling liquid that exit the water pump are collected in this reservoir. The cooling liquid therefore remains in the reservoir, where it cannot be seen from the outside, and it evaporates there.

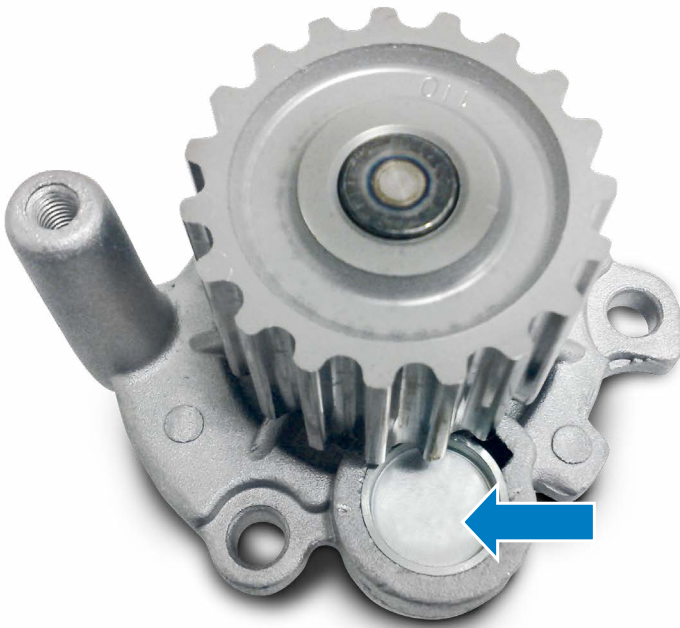

Cover on cooling liquid reservoir

1.8 SEALING OF THE PUMP HOUSING

Elastomer seals

Elastomer seals are frequently used to seal the water pump to the engine block. The rectangular or round elastomer sealing ring is positioned in a sealing ring groove in the water pump.

ATTENTION

No additional liquid sealants may be used in combination elastomer sealing rings.

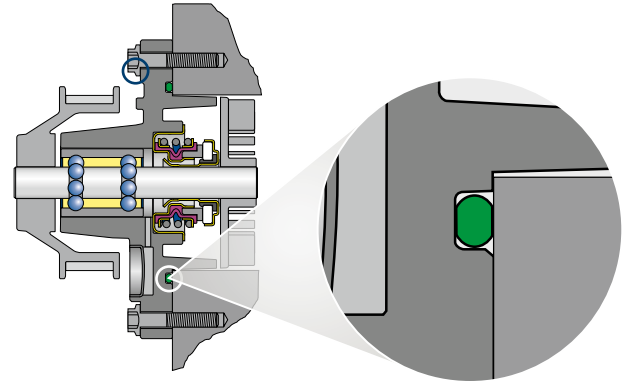

Elastomer seal

Gaskets

Gaskets do not normally require any additional liquid sealant. The sealing material of the gasket can securely seal even the smallest areas of unevenness on the sealing area.

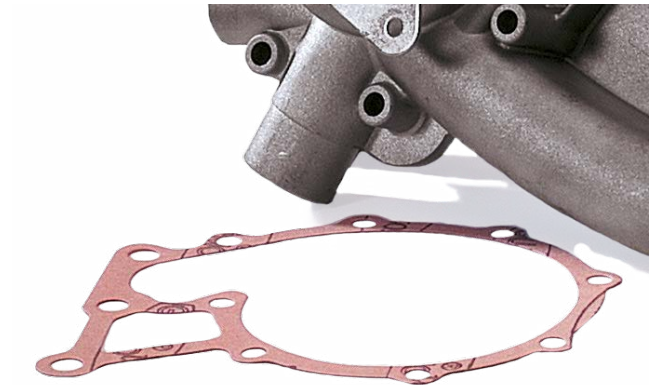

Water pump with gasket

Liquid sealants

It is rare for pumps to be sealed using only liquid sealants. If this type of sealing is specified, you must pay attention to the installation instructions from the engine manufacturer.



Liquid sealants

1.9 COOLING LIQUID

The cooling liquid is the transport medium that is used to transport the waste heat of the engine to the radiator or the heating cooler. Special cooling liquid compositions make a significant contribution to the proper function of the cooling system. In liquid-cooled vehicle engines – with a few exceptions, such as oil cooling – the cooling liquid consists of a mixture of water and coolant agent.

In terms of the function and the task, the correct cooling liquid is as important as the engine oil. Incorrect specifications, an unsuitable mix ratio, irregular replacement of the cooling liquid and/or ageing of the cooling liquid lead to corrosion and premature failure of the water pump and other engine parts. The additives in the coolant agent function as ageing stabilisers, corrosion protection, anti-foam agent, detergents and coating material. All additives ensure the proper function and condition of the cooling liquid in accordance with the regulations until the next change.

Some of the most important functions and facts regarding coolant agent are stated below.

ATTENTION

It is frequently stated that glycol-based coolant agent only functions as anti-freeze. However, the anti-freeze function is only one of several requirements. Coolant agent is generally required in order to protect the cooling system against corrosion.

Anti-freeze function of the coolant agents

The main component of the coolant agent is monoethylene glycol, which has a very low freezing point.

The cooling liquid used in the cooling system consists of a mixture of pure coolant agent and water that must be produced in a particular ratio in accordance with the engine manufacturer's instructions. A frequently used mix ratio is 50:50.

Undiluted coolant agent must not be used, even in areas in which very low frost temperatures are possible. If the coolant agent is mixed with an insufficient amount of water or if undiluted coolant agent is used, the anti-freeze effect reverses at a certain temperature. This means that the cooling liquid can freeze even at temperatures above -15°C , despite the high concentration of coolant agent.

Freezing curve based on the mix ratio of the cooling liquid

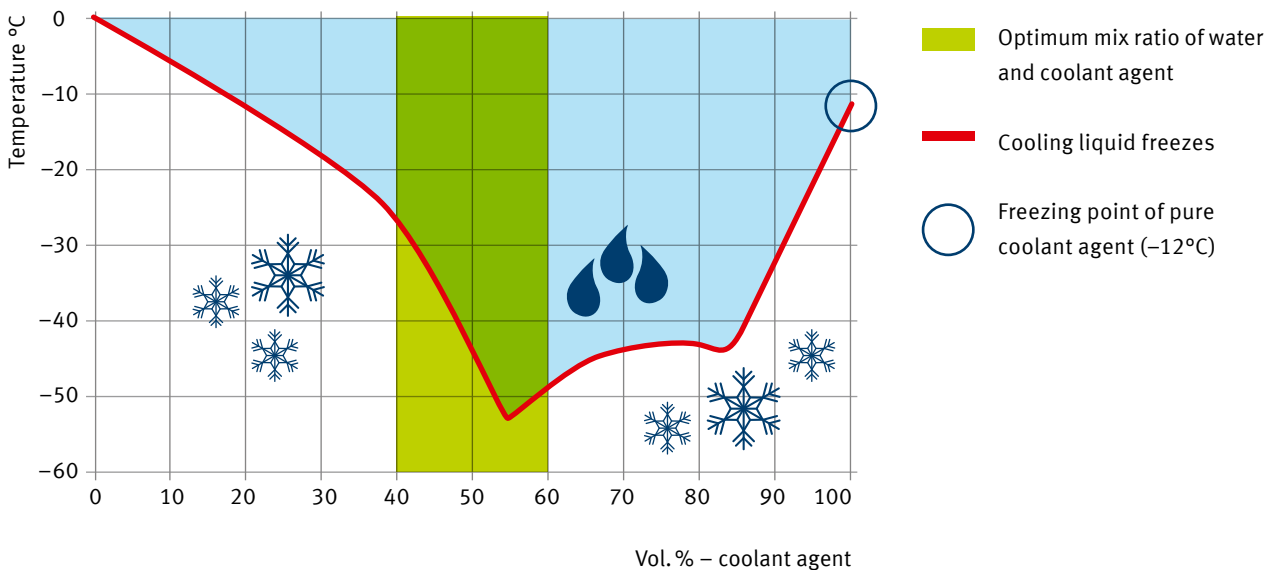

Thermal absorption capacity of the coolant agent

Pure coolant agent has a lower thermal absorption capacity than normal water. This means that a 50:50 mixture of coolant agent and water is unable to transport as much heat to the radiator as normal water. The engine manufacturer has taken this reduced thermal absorption capacity of the coolant agent into account in designing the cooling system. The circulating velocity of the water pump, the size of the radiator and the amount of cooling liquid have been adjusted accordingly. If coolant agent is mixed into the cooling liquid and the vehicle radiator has sufficient dimensions, then the engine itself is protected against overheating even in hot areas.*

Engines that are improperly operated using pure water may never reach the correct operating temperature as this means that the cooling system is oversized. For more detailed information on this topic, see chapter „3. Damage and causes of failure“.

Increasing the boiling point

The boiling point of cooling liquid increases when the proportion of coolant agent is raised. At the level of air pressure present at sea level, pure water has a boiling point of 100°C. For pure coolant agent based on monoethylene glycol, the boiling point is over 160°C. The proportion of coolant agent therefore has a considerable influence on the boiling point of the cooling liquid. This means that the cooling liquid will only reach the boiling point at considerably higher temperatures in accordance with the proportion of coolant agent. This acts as a safety reserve in order to prevent cavitation on the engine components. The operating pressure in the cooling system (approx. 1 bar) further increases the boiling point.

The graphic shows the vapour pressure curves of certain glycol / water mixtures. The resulting boiling points can be read out at the respective intersections, for example at a operating pressure of 1 bar in the cooling system and with various mix ratios.

* In the case of used vehicles (facility vehicle) that were sold from temperate latitudes to hot climate zones, the size of the vehicle radiator may need to be adjusted in accordance with the manufacturer’s instructions in order to prevent the engine from overheating. This is something that cannot be effectively prevented by operating the cooling system with pure water and / or with the thermostat removed.

Vapour pressure curves for glycol / water mixtures

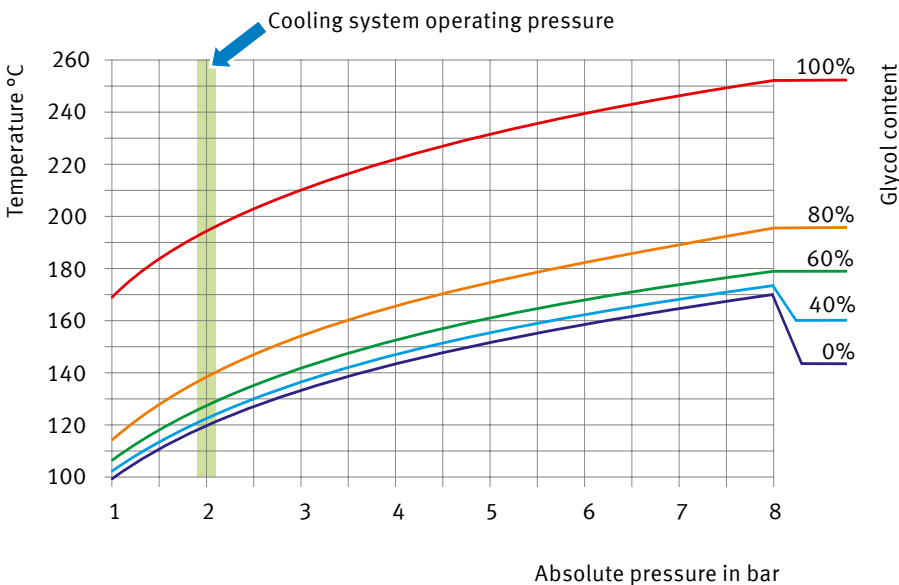

Corrosion protection

The most important task of the coolant agent is to protect the cooling system against corrosion, which primarily affects the durability of the entire engine.

Due to a lack of corrosion-inhibiting substances in the cooling liquid, the salts and acids that may be present in the cooling liquid lead to components being chemically attacked (corrosion). In the long term, this deteriorates the engine components. Aluminium corrosion is a common problem in cooling systems in particular.

The oxygen present in the water also oxidises with ferrous materials and pollutes the cooling liquid with solids (rust). The relatively hard rust particles lead to rapid wear on the sliding ring seal of the water pump.

In order to counteract the corrosion, the coolant agent has alkaline properties. The pH value is around 8, providing a buffer effect with regard to acids that enter the cooling system. The buffer effect is decreasing over time. Salty water, rainwater, deposits of radiator decalcifiers or combustion gases that enter the cooling liquid can move the ratio of acids to bases into the acidic range. Pure (distilled) water has a pH value of 7 and therefore features neutral properties.

The graphic shows the individual pH value range covered by the various example liquids.

pH value table



pH value		Example
14	Alkaline	Sodium hydroxide
13		
12		Ammonia
11		
10		Soap solution
9		
8		Seawater
7	Neutral	Pure water
6	Acidic	Milk
5		Rainwater, sparkling mineral water
4		Cola
3		Vinegar
2		Lemon juice
1		Battery acid, gastric acid
0		Hydrochloric acid

Coolant agent specifications

Today, we fundamentally distinguish between three conventional forms of coolant agent technologies:

- **Siliceous hybrid coolant agent based on monoethylene glycol (MEG, colour mostly greenish blue, orange or yellow)**

Inorganic and organic inhibitors are responsible for corrosion protection. The silicates contained in this form a thin and stable protective layer that protects the cooling system against corrosion, cavitation and deposits.

- **Silicate-free coolant agent based on organic acids (OAT – Organic Acid Technology, normally red / violet in colour)**

In these coolant agents, organic salts are responsible for corrosion protection.

- **The latest generation of Si-OAT coolant agents (colour mostly blueish violet)**

This is a combination of hybrid and OAT coolant agents with improved corrosion protection. Highly reactive silicon additives form extremely stable and dynamic protective layers.



NOTE

The colouring of the coolant agents is not standardised. Two coolant agents may not necessarily be comparable despite having the same colour, although the colours used by well-known coolant agent manufacturers do correspond in some cases. Low-price suppliers often present their coolant agents in neon colours. Very poor quality coolant agents are sold in some countries. We recommend exercising particular caution in such cases as the stipulated specifications may not be met. It is essential to use the coolant agent approved by the engine manufacturer. The part of the label that states „corresponds to the standard...“ is not a manufacturer approval!



ATTENTION

Never mix siliceous and silicate-free coolant agent!

- This diminishes the corrosion protection.
- The cooling liquid may become gelatinous or flocculation may occur.
- There may be damage to the sealing ring cartridge.
- The cooling system may leak!

2. INSTALLATION AND SERVICE

2.1 CLEANING THE COOLING SYSTEM

Contaminated cooling systems are one of the principal causes that lead to leaking water pumps. If the cooling liquid is rusty, calcified, polluted or oily, the cooling system must be purged with clean water and / or de-oiled / decalcified using the corresponding cleaners prior to the replacement of the old water pump.

If the freezing point of the cooling liquid has been measured, for example using an aerometer, and the result reveals the frost protection to be sufficient, this is not an indicator of the ongoing usability of the cooling liquid. This result only implies that the anti-freeze function of the cooling liquid is still sufficient to prevent the cooling liquid from freezing.

Dirty, milky or murky cooling liquid is a sign that the change intervals for the cooling liquid were not adhered to or that unsuitable cooling liquid was poured in. A leaking cylinder head gasket can also generate symptoms such as these. If exhaust gases should enter the cooling liquid, the pH value is reduced and it is easier for corrosion to take place.

If the colour of the cooling liquid cannot be defined or if flocculation occurs, this indicates that coolant agents with differing compositions were mixed with one another. In this case, the cooling system must be carefully purged and the cooling liquid must be completely replaced.



ENVIRONMENT

Used cooling liquid must not be reused. It must be collected and disposed of in accordance with the local regulations. Old cooling liquid must not enter the waste water system or the environment. As old cooling liquid contains chlorine compounds and other components, it must not be mixed with old engine oil and disposed of.



Contaminated, discoloured, oily or rusty cooling liquid indicates that the cooling liquid must be changed immediately. In general, the cooling liquid should be checked at all maintenance intervals and not just in the event of water pump failure.

2.2 DISMANTLING THE OLD WATER PUMP

Remove the old water pump in accordance with the manufacturer's instructions. Old fragments of the gasket and corrosion must be carefully removed from the sealing areas on the engine block. Abraded fragments of gasket must not get into the cooling system.

If the cooling system is to be purged, this should be carried out prior to the dismantling of the old water pump for practical reasons.

2.3 INSTALLING THE NEW WATER PUMP

The cleaned sealing areas must be degreased prior to the installation of the new water pump to ensure that liquid sealants or gaskets are able to bond and seal well. In a housing sealed with elastomer seals, it may be necessary to apply some lubricant to the counter face of the engine block. This prevents the sealing ring from twisting, jamming or being damaged when the water pump is inserted.

ATTENTION

When installing the new water pump, it is essential to observe the tightening torques stipulated by the engine manufacturer and the tightening sequence of the screws.

2.4 GASKETS AND LIQUID SEALANTS

Water pumps with O-rings or rectangular rings made from elastomers must not be fitted with additional liquid sealants apart from the sealing ring. Sufficient free space must be available in order for deformations (ovalisation) to be adapted by the sealing ring once it has been fitted. If this free space is additionally filled with liquid sealant, it is no longer possible to guarantee proper function of the elastomer seal.

If gaskets are used for the purpose of sealing the water pump, no additional sealant may be applied if the sealing area on the engine block is in perfect condition. A small amount of liquid sealant may only be used between the engine block and the gasket in the case of highly corroded or scratched sealing areas that can no longer be levelled using sandpaper. However, sealant should

only be applied with a maximum diameter of 2 mm. If this is not the case, then too much sealant will be squeezed out, potentially damaging the sliding ring seal (see chapter „3. Damage and causes of failure“). The cooling liquid must only be poured in once the sealant has hardened, as this prevents sealant that is still soft from entering the sealing gap of the sliding ring sealing cartridge.

ATTENTION

Do not use too much sealant! Excess sealant can pollute the cooling system and destroy the sliding ring seal. It can also cause malfunctions, for example in thermostats, electrical heater valves and circulating pumps of auxiliary heaters.

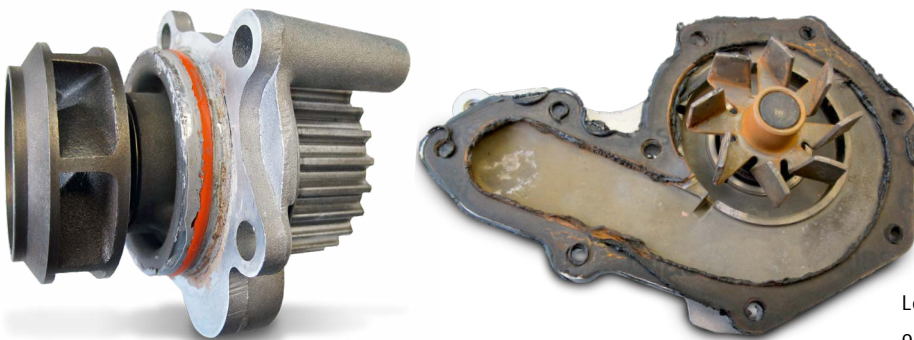

Leaky water pumps caused by the use of liquid sealant

2.5 BELT DRIVE AND BELT TENSION

You must proceed with extreme caution when mounting the drive belt and adjusting the belt tension. If automatic belt tensioners are present, these must be exchanged and adjusted in accordance with the manufacturer's instructions. If the water pump is driven by a timing belt, then it must also be replaced in order to ensure the operational safety of the engine and due to the amount of work involved in replacing the water pump. The same applies for all tensioning and guide rollers. Damaged pulleys must be replaced.

Adjustments must be made to the valve timing, the belt tension and the fuel injection pump in accordance with the engine manufacturer's instructions. Excessive tension or insufficient tension on the belt causes damage to the water pump bearing. In the case of belts that are excessively tensioned, the permissible bearing load is exceeded and the bearing is destroyed within a few thousand kilometres. If the belt is insufficiently tensioned, the slacking of the belt can cause vibrations and uneven running. This also reduces the service life of the water pump bearing.

2.6 V-BELT AND V-BELT PULLEYS

V-belts (Fig. 2–4) wear more quickly than flat poly-rib belts (poly V-belt, poly-rib, Fig. 1). This is due to the increased flexing work performed by the belt. The associated belt slip wears out the V-belt on both flanks. The same applies for the V-belt pulleys. Due to the long service life, the V-belt pulleys may be so worn that even a new belt cannot be carried on the flanks. The force transmission then occurs either at the edges of the V-belt (Fig. 3) or via the inside diameter of the belt and the base diameter of the pulley (Fig. 4). In both cases, this wear reduces the clearance between the belt and the shaft. This changes the transmission ratio of the belt drive and can lead to premature component failure.

If the pulleys are worn, even a new belt will generate squeaking noises after a brief period of operation. The squeaking indicates belt slip. The belt tension is commonly increased as a counter measure, but this causes overtensioning of the belt. This can lead to overstressing of the bearings in the water pump, the servo pump and the alternator and can ultimately lead to component failure.

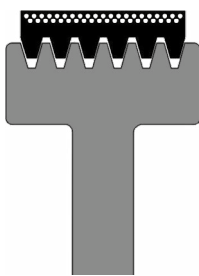

Fig. 1

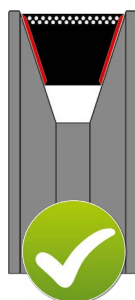

Fig. 2

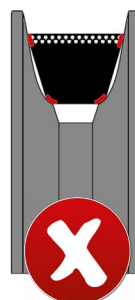

Fig. 3

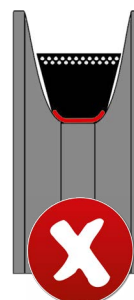

Fig. 4

2.7 FILLING THE COOLING SYSTEM

When filling the cooling system, you must ensure that trapped air can escape. For this purpose, you must open any bleed screws and mechanical heater valves that are present.

NOTE

Some cooling systems are difficult to fill due to their design. In these cases, it is essential that filling is performed in accordance with the vehicle manufacturer's instructions.



Tip: The vacuum filling procedure can be used to prevent air being trapped in the cooling system. First, a vacuum filling device is used to suck all the air out of the cooling system (evacuation). The valves are then switched such that the vacuum sucks the cooling liquid out of the canister into the cooling system. The advantages offered by this procedure are not limited to the bubble-free filling of the cooling system. When the system is evacuated, the fact that the vacuum does not form in the cooling system means that leakages can also be detected immediately. The vacuum filling procedure is used and / or is a stipulated requirement at the premises of many vehicle manufacturers, in the areas of both vehicle production and service. The corresponding filling devices are available from tool retailers.

2.8 INITIAL START-UP

ATTENTION

The water pump must not be turned with a dry sliding ring seal.

The water pump must not be operated under any circumstances without cooling liquid having been poured in first. This requirement also applies to brief operations, such as checking whether the belt tension is OK or checking whether the engine starts up at all. If the water pump is operated without cooling liquid, both sliding rings rub dry against one another without any lubrication and without any cooling. This immediately leads to significant wear and thermal destruction of the sliding ring seal.

This is also the case if there is a loss of cooling liquid during the journey and the vehicle is driven to the next repair shop while the engine temperature is monitored. Even if only a short distance is covered, the water pump is normally irreparably damaged or destroyed as a result.

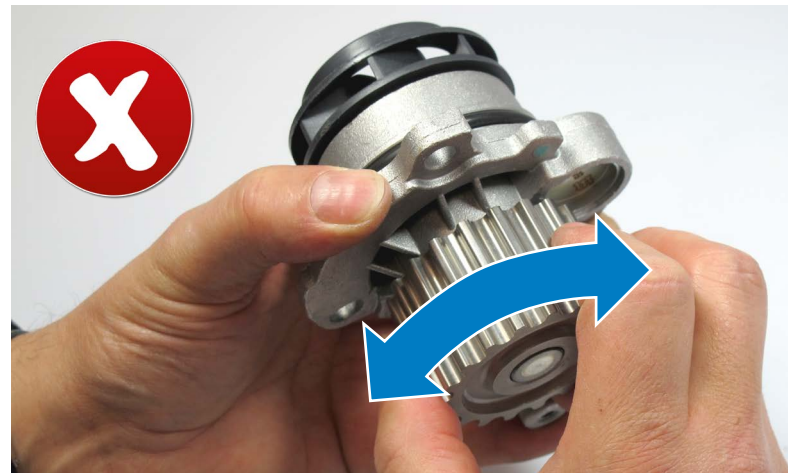

Water pumps must not be turned when dry

2.9 RUNNING-IN THE WATER PUMP

As with every other moving engine part, the water pump also requires running-in time. The surfaces of both sliding rings must adapt to one another. It is normal for a small amount of cooling liquid to be visibly discharged at the leakage hole of the water

pump during the running-in time. The cooling liquid discharge stops following the running-in of the sliding rings (1–3 hours of operation).

2.10 MIXING THE COOLING LIQUID

If not otherwise stated by the engine manufacturer, a mix ratio of 50:50 for the coolant agent and the water is a proven option. Many coolant agent manufacturers provide ready-to-use cooling liquid, in which case the mixing stage is omitted.



ATTENTION

Under no circumstances may water be used in the cooling system without the addition of coolant agent.

The water used should be of drinking water quality and not be too hard. The hardness level should be no more than 3,56 mmol/l. Drinking water from seawater desalination plants should not be used, as the residual content of the dissolved salts will quickly lead to corrosion in the cooling system. Distilled water* may be used if no suitable (still) drinking water is available. Rainwater, water from the ocean and dead waters must not be used.

Water and coolant agent must always be mixed outside the cooling system. Avoid pouring pure coolant agent into the cooling system in order to then top up the residual amount with water. The silicates contained in the coolant agent form a protective coating in the cooling system. If you start by filling the cooling system with pure coolant agent, an excessively thick protective coating will form due to the high concentration at the more low-lying surfaces of the cooling system. In this case, the content of silicate is no longer sufficient in order to guarantee the protective coating across the entire surface of the cooling system.

Calcification is formed in the cooling system, for example, if a leaking cooling system is constantly refilled with water. If water is topped up, new hardeners are added with each filling procedure. These are deposited in the cooling system in the form of scale deposits (calcium carbonate and magnesium carbonate) and impede the heat exchange. Loose scale particles lead to abrasive wear of the sliding ring seal and failure of the water pump.



Tip: If only highly calciferous water is available for the purpose of mixing the cooling liquid, you can boil the water in order to remove some of the substances that promote hardening. This breaks down the carbonate hardness into scale deposits, meaning that it is no longer able to form any deposits in the cooling system.

*Distilled water is very low in minerals. As a result, even experts frequently have doubts as to whether this water should be used for the purpose of mixing the cooling liquid. The strong corrosion protection provided by pure coolant agent means that the use of distilled water does not have any negative effects.

2.11 THE MOST IMPORTANT RULES FOR HANDLING WATER PUMPS AND COOLING LIQUID



- Use only specified cooling liquid.
- Observe the change intervals of the cooling liquid.
- Defective or damaged viscous couplings or fan blades must be replaced.
- Only use liquid housing sealants where these are specified.
- You must adhere to the specified belt tension.
- It is essential that you replace and adjust tension pulleys and automatic belt tensioners in accordance with the manufacturer's instructions.
- Ensure venting of the cooling system.



- The pump shafts of new water pumps must never be turned back and forth by hand.
- Do not use any worn, damaged or bent pulleys.
- No radiator sealant additives may be mixed into the cooling liquid.
- Never ever operate water pumps without cooling liquid.

3. DAMAGE AND CAUSES OF FAILURE

3.1 BEARING DAMAGE

Premature bearing damage will always occur if the maximum permissible radial or axial stress is exceeded. If excess cooling liquid is discharged following damage to the sliding ring seal, this can enter into the bearing housing and lead to bearing failure (loss of lubrication, corrosion).

The reasons for failure are:

- Excess tensioning of the drive belt (overstressing of the bearings).
- Insufficient tensioning of the drive belt, leads to increased bearing stress due to the impact of the belt and the torsional vibrations.
- Worn, incorrect or bent pulleys, belt alignment errors, one-sided stress, vibrations (see illustration).
- Automatic tensioners that are defective or incorrectly mounted.
- Defective viscous couplings for the cooling fan (vibrations).
- Fan blades that are defective, bent or incorrect (vibrations).
- Defective vibration dampers on the crankshaft (vibrations, belt alignment errors).
- Incorrect and damaged drive belts.
- Ingress of water into the pump bearing due to:
 - Driving through water.
 - Cleaning the engine using high-pressure cleaning devices.
 - Leaking sliding ring seal (ignoring the loss of coolant from the water pump and constantly refilling the cooling liquid).
- Reaching the end of normal service life due to wear.
- Installing a water pump that is not suitable for the application.



Bearing damage due to belt problems (rubber abrasion, particulate on the housing)

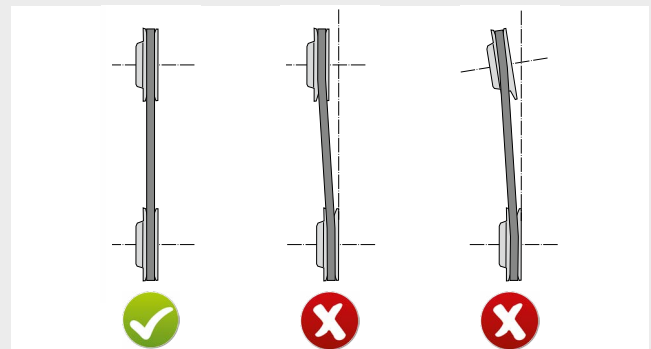

Belt alignment errors



Bearing damage due to excess belt tension

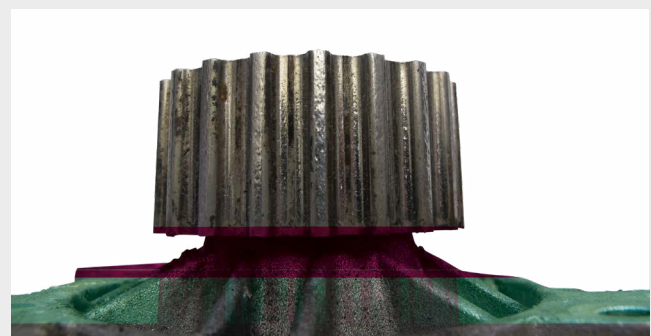

Toothed belt pulley damaged by dirt and wear (bearing damage)

3.2 LEAKS

The sliding ring seal is normally damaged by dry running of the water pump (lack of cooling liquid) and due to polluted cooling liquid. Both issues lead to abrasive seal wear and premature failure of the water pump.

Causes of leakage:

- Operation of the water pump without cooling liquid.
- Contaminated cooling liquid (rust, corrosion products, lime, liquid sealant, oil, sand, etc.).
- Turning the new water pump by hand (damaging the sliding ring seal). The sliding ring seal, which is still dry, starts making a squeaking noise. The longer the pump shaft is turned back and forth, the louder the squeaking becomes.
- Use of incorrect, corrosive or unsuitable cooling liquid.
- Impacts on the pump shaft (sliding ring seal fracture due to vehicle accident or inexpert installation).
- Pump bearing worn-out.
- Use of radiator sealant additives in the cooling liquid (sliding ring seals are stuck).

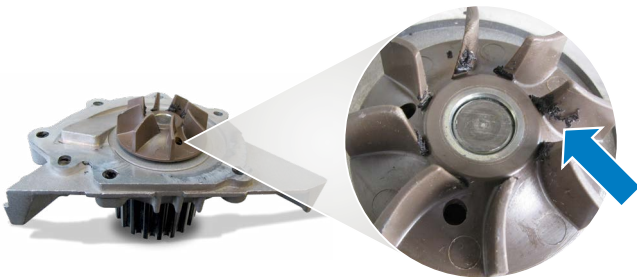

Leaky water pump caused by liquid sealant (pump was already leaking during the warm-up phase)

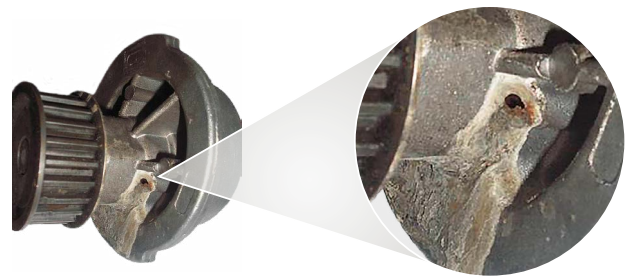

Leaky water pump caused by calciferous water

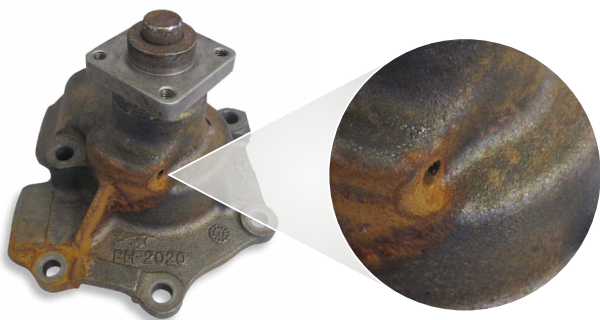

Leaky water pump caused by rust in the cooling liquid (lack of corrosion protection in the cooling liquid)

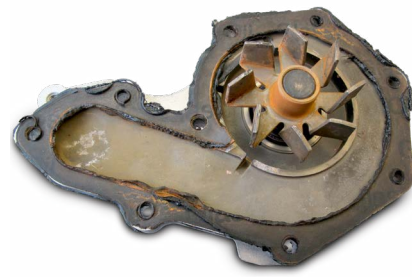

Excess use of liquid sealants (in this case, silicone)

3.3 CAVITATION

Water pumps can sustain holes due to cavitation on the housing, causing them to leak. In certain circumstances, metal pump impellers are sufficiently weakened by cavitation that they break. The cavitation is often only detected once the water pump has been dismantled.

Cavitation is the result of:

- Maintenance errors
- Improper operating conditions
- Cooling system malfunction
- Incorrect cooling liquid

Cavitation may also indicate that the water pump was not installed with due care and attention.

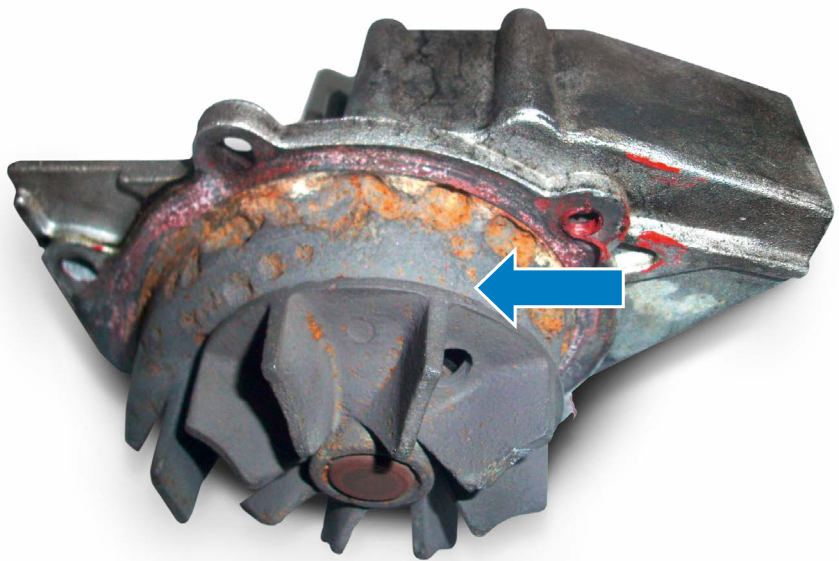

Pump housing damaged by cavitation

Origin of cavitation

When liquids reach their boiling point, small vapour bubbles are formed that suddenly collapse (implode). When the bubbles disintegrate, a micro jet is characteristically formed in the middle of the bubble. The liquid is sharply accelerated in the micro jet. Pressure peaks of up to 10,000 bar and speeds of up to 400 km / h impact the component surface in individual places.

This causes small metal particles to be torn from the component surface by mechanical means. If the cavitation always occurs at the same location, increasingly deep holes or cavities will be formed over time.

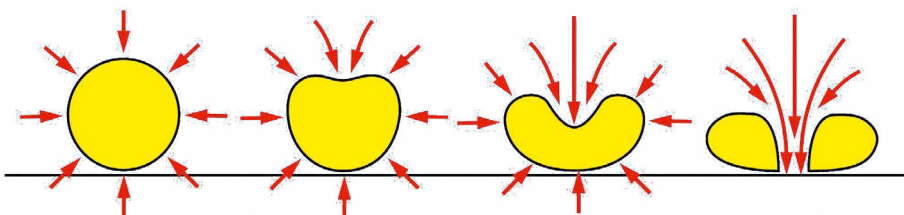

Bubble formation and bubble disintegration

Vapour bubbles are formed when the boiling point of a liquid is reached. This is dependent on three parameters:

1. The boiling point of the liquid itself.
2. The pressure in the liquid.
3. The temperature of the liquid.

These three parameters influence one another. Please see below for the causes that govern the way in which the boiling point can be reached in an engine cooling system. The attainment of the boiling point and the occurrence of cavitation are often due to multiple causes at the same time.

Reaching the boiling point due to low operating pressure in the cooling system

- Leaking cooling system.
- Faulty or incorrect radiator filler cap – incorrect opening pressure of the pressure relief valve.
- Insufficient operating temperature of the engine – engine operation without thermostat, or thermostat with insufficient opening temperature.
- Engine operation in high mountain regions – the low ambient pressure also affects the operating pressure in the cooling system.

Reaching the boiling point due to fast movements of liquids and objects

- Local low-pressure zones on components caused by oscillation of components.
- Local low-pressure zones due to fast movements of components in liquids, particularly in pump impellers and propellers.
- High flow velocity of liquids combined with a sharp change in the direction of flow or with flow reversal. If the flow velocity is so high that the static pressure falls below the evaporation pressure of the liquid, this leads to the formation of vapour bubbles.

Cooling liquid boiling point too low

- Use of normal water without the addition of coolant agent.
- Unsuitable cooling liquid (insufficient coolant agent concentration, ageing cooling liquid). Also see chapter „1.9 Cooling liquid“.

Reaching the boiling point due to excess component temperature

Due to overstressing of the engine or malfunctions in the combustion process, more heat is generated than stated in the specification.

Poor functioning of the cooling system, for example due to a lack of coolant liquid, blocked radiator, pollution on the outer face of the radiator, defective viscous couplings, worn drive belt, failure of the electrical cooling fan, etc.

3.4 CORROSION

Corrosion loosens solid particles from the surfaces of the cooling system. The particulate enters between the sliding ring seal of the water pump. The abrasive wear causes the sliding ring seal to leak. Corrosion on the inside surfaces of the water pump indicates that the cooling liquid in use provides insufficient corrosion protection.

Causes of corrosion:

- Incorrect, corrosive, ageing or unsuitable cooling liquid.
- Use of water as cooling liquid (without the addition of any coolant agent).
- Leaking cylinder head gasket: Aggressive combustion gases such as carbon dioxide (CO_2) and sulphur compounds (H_2SO_3) enter into the cooling system and lead to the acidification of the cooling liquid and the breakdown of the corrosion-inhibiting substances.
- Reduction of the corrosion protection effect of the cooling liquid caused by mixing coolant agents with differing compositions (see chapter „1.9 Cooling liquid“).

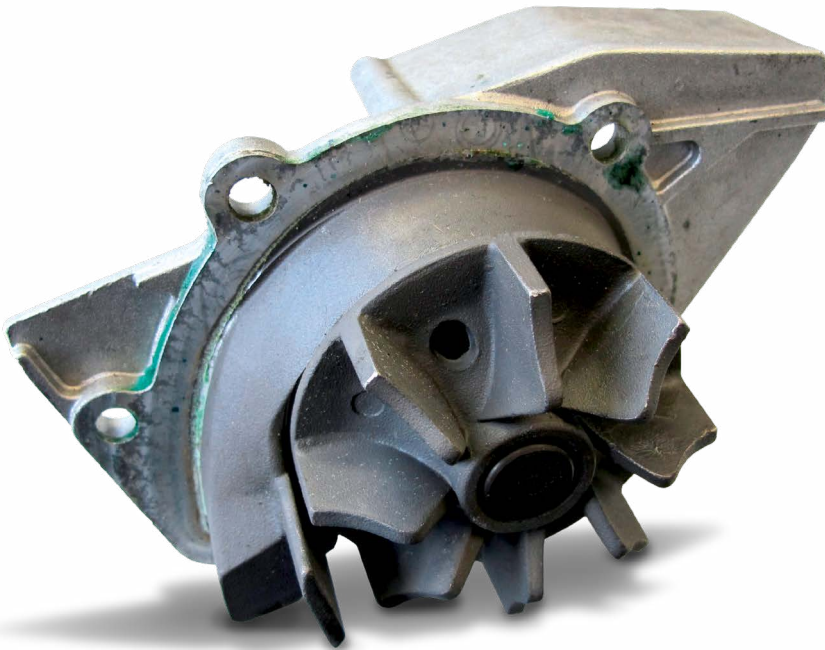

Unsuitable cooling liquid has led to corrosion and leakage



The alkaline reaction of the cooling liquid leads to normal grey colouring of aluminium parts. However, there must not be any loose deposits (sludge, or dust if dry) on the surfaces that have been coloured grey (finger test). If these are present, this indicates that the cause is material corrosion rather than the alkaline reaction of the coolant agent. The loosened solids generated by this pollute the cooling liquid and lead to abrasive wear on the sliding ring seal.



KNOW-HOW TRANSFER

PROFESSIONAL KNOWLEDGE FROM THE EXPERTS

WORLDWIDE TRAININGS

Each year, around 4,500 mechanics and engineers benefit from our training courses and seminars, which we hold on-site in locations across the world or in our training centres in Neuenstadt, Dormagen and Tamm (Germany).

TECHNICAL INFORMATION

Our Product Information and Service Information publications, technical brochures and posters keep you at the forefront of the latest technological developments.

TECHNICAL VIDEOS

Our videos provide you with useful information on our products, such as hands-on fitting instructions and system descriptions.

 **YouTube**

PRODUCTS IN FOCUS ONLINE

Interactive elements, animations and video clips provide interesting information about our products in and around the engine.

ONLINESHOP

Order at any time. Quick availability check. Extensive product search by engine, vehicle, dimensions etc.

NEWS

Subscribe online to our free newsletter now and receive regular information about additions to the product range, technical publications and much more.

INDIVIDUAL INFORMATION

We provide extensive information and services relating to our wide range of services: e.g. personalised sales-promoting materials, sales support, technical support and much more.

 **RHEINMETALL** 

TECHNIPEDIA

We share our know-how with you in our Technipedia. You can get professional knowledge direct from experts here.

MOTORSERVICE APP

Here, you will find the latest information and services relating to our products quickly and easily.

SOCIAL MEDIA

Always up to date



HEADQUARTERS:

MS Motorservice International GmbH

Wilhelm-Maybach-Straße 14–18

74196 Neuenstadt, Germany

www.ms-motorservice.com

www.rheinmetall.com

© MS Motorservice International GmbH – 50003 701-02 – EN – 05/15 (112022)

